

PRODUCT FACT SHEET

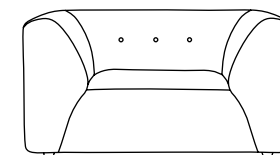

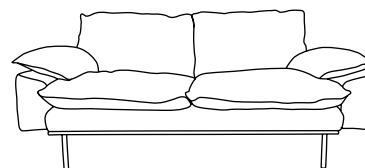
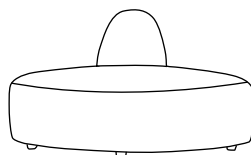
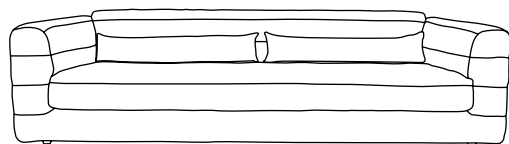
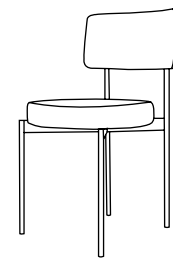
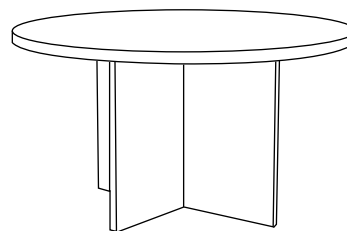
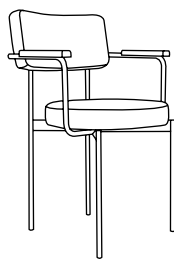
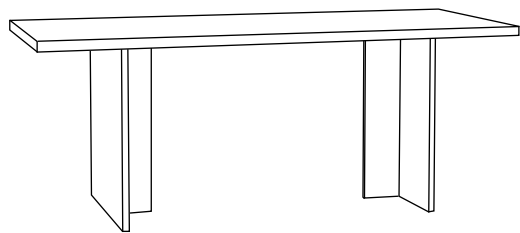

DINING ARMCHAIR

Product fact sheet

For all possibilities and corresponding prices, please visit our website.

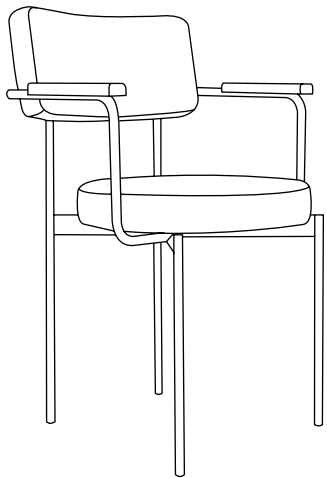

Dining

Armchair

Overall dimensions (L*W*H):

56x54x81 cm

Back height:

34 cm

Armrest height:

66 cm

Seat height:

47 cm

Seat depth:

44 cm

Seating width:

44 cm

Fabric options:



Yoredale
Kidstone



Yoredale
Askrigg



Main Line Flax
Kensington



Main Line Flax
Goldhawk



Main Line Flax
Upminster



Main Line Flax
Morden

Frame options:



RAL 1011
Dusty



RAL 7034
Olive



RAL 3012
Nude



Black

Handles:

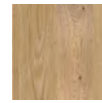

Oak wood
armrest → comes
with the coloured
frames



Black beech wood
armrest → comes
with the black
frame

DINING CHAIR

Product fact sheet

For all possibilities and corresponding prices, please visit our website.

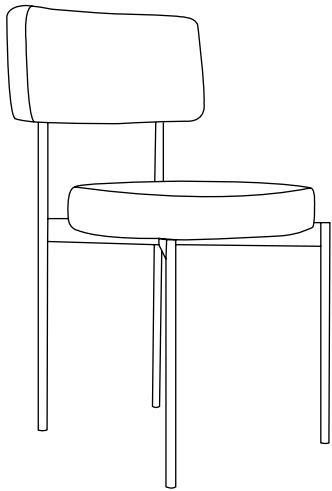

Dining Chair

Overall dimensions (L*W*H):
46x54x81 cm

Back height:
34 cm

Seat height:
47 cm

Seat depth:
44 cm

Seating width:
44 cm

Fabric options:



Yoredale
Kidstone



Yoredale
Askrigg



Main Line Flax
Kensington



Main Line Flax
Goldhawk



Main Line Flax
Upminster



Main Line Flax
Morden

Frame options:



RAL 1011
Dusty



RAL 7034
Olive



RAL 3012
Nude



Black

FABRIC SPECIFICATIONS

For all possibilities and corresponding prices, please visit our website.

Yoredale, Main Line Flax

Dining (arm)chair

Yoredale

Colours:

Kidstone

Askrigg



Fabric covering specifications:

Composition faceside: 95% Wool, 3% Polyester, 2% Polyamide

Composition backing: N/A

Coating: -

Material weight: 700 g/lm

Abrasion resistance (EN ISO 12947 1 & 2): 50.000 cycles, Martindale

Pilling resistance (EN ISO 12945-2): Class 4

Lightfastness (EN ISO B02): Class 5

EN 1021, 1&2 (cigarette & match) ✓

BS 7176 Low Hazards ✓

Filling and body:

Frame: Powder coated metal

Black armrest: 100% Beech wood

Coloured armrest: 100% Oak wood

Seat filling: 12039 foam (Polyurethane Foam)

Back filling: 12039 foam (Polyurethane Foam)

Optional: Crib 5 compliant (according to the UK Fire Regulations)

Dining (arm)chair

Main Line Flax

Colours:

Kensington

Goldhawk

Upminster

Morden



Fabric covering specifications:

Composition faceside: 75% Virgin Wool, 25% Flax

Composition backing: N/A

Coating: -

Material weight: 437 g/lm

Abrasion resistance (EN ISO 12947 1 & 2): 50.000 cycles, Martindale

Pilling resistance (EN ISO 12945-2): Class 3

Lightfastness (EN ISO B02): Class 5

EN 1021, 1&2 (cigarette & match) ✓

BS 7176, Low Hazards ✓

BS 5852 Ignition Source 5 ✓

BS7176 Medium Hazard ✓

Care instructions:

Vacuum regularly. Wipe with a damp cloth using soap and water or use proprietary upholstery shampoo. For deeper cleaning use steam or professionally dry clean. Avoid contact with sharp objects.



DINING TABLE ROUND

Product fact sheet

For all possibilities and corresponding prices, please visit our website.

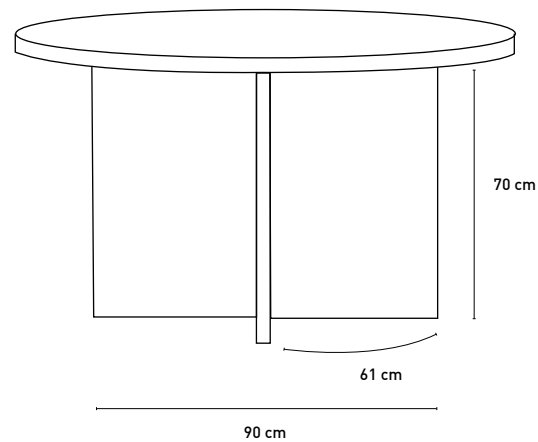

Dining Table

Round

Overall dimensions (L*W*H):

129x129x74 cm

Table top thickness:

4 cm

Legs height:

70 cm

Legs width:

90 cm

Legs thickness:

3 cm

Legs inner measurement:

61 cm

Material specifications:

Composition:

70% Eurolight, 22% MDF,
7% 0,9 mm HPL Abet, 1% Metal

Legs:

Legs can be adjusted to avoid wobbling.

Care instructions:

Use non-abrasive cleaning tools. Possibly avoid leaving dirt and stains for long time on the surface of the laminate. To avoid leaving marks, always remove the detergent, rinse and dry well. It is advisable to proceed with a preliminary test on a small portion of the surface. Do not use aggressive products (for example: muriatic acid, products for cleaning silver and caustic soda).

Colour options:



Orange

Blue

Green

Brown

Cream

Pink

DINING TABLE RECTANGULAR

For all possibilities and corresponding prices, please visit our website.

Product fact sheet

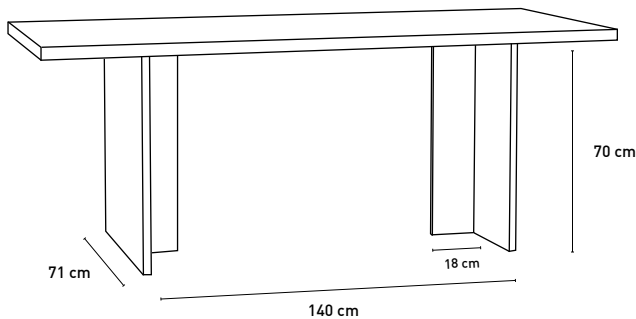

Dining Table

Rectangular 220 cm

Overall dimensions (L*W*H):

220x90x74 cm

Table top thickness:

4 cm

Legs height:

70 cm

Legs width:

71 cm

Legs thickness:

3 cm

Legs inner measurement:

140 cm

Material specifications:

Composition:

70% Eurolight, 22% MDF,
7% 0,9 mm HPL Abet, 1% Metal

Legs:

Legs can be adjusted to avoid
wobbling.

Colour options:

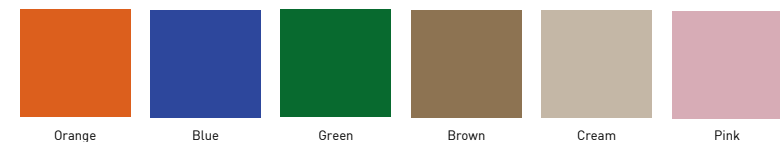

Care instructions:

Use non-abrasive cleaning tools. Possibly avoid leaving dirt and stains for long time on the surface of the laminate. To avoid leaving marks, always remove the detergent, rinse and dry well. It is advisable to proceed with a preliminary test on a small portion of the surface. Do not use aggressive products (for example: muriatic acid, products for cleaning silver and caustic soda).

DINING TABLE RECTANGULAR

Product fact sheet

For all possibilities and corresponding prices, please visit our website.

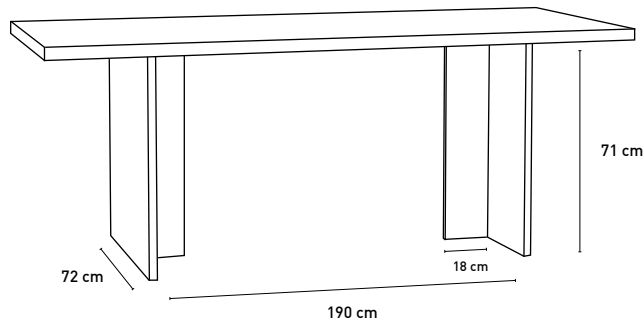

Dining Table

Rectangular 280 cm

Overall dimensions (L*W*H):
278x100x74 cm

Table top thickness:
4 cm

Legs height:
70 cm

Legs width:
72 cm

Legs thickness:
3 cm

Legs inner measurement:
190 cm

Material specifications:

Composition:
70% Eurolight, 22% MDF,
7% 0,9 mm HPL Abet, 1% Metal

Legs:

Legs can be adjusted to avoid wobbling.

Colour options:

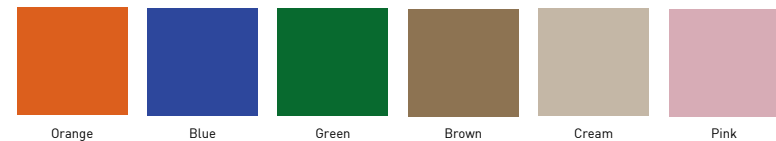

Care instructions:

Use non-abrasive cleaning tools. Possibly avoid leaving dirt and stains for long time on the surface of the laminate. To avoid leaving marks, always remove the detergent, rinse and dry well. It is advisable to proceed with a preliminary test on a small portion of the surface. Do not use aggressive products (for example: muriatic acid, products for cleaning silver and caustic soda).



ACRYLIC CABINET 160 CM

Product fact sheet

For all possibilities and corresponding prices, please visit our website.

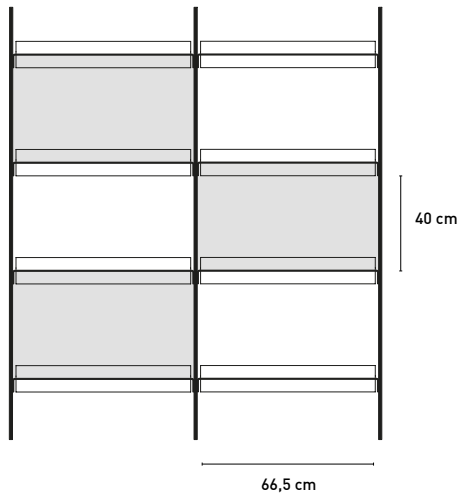

Acrylic Cabinet

Modular

See next page for modular options

Overall dimensions (L*W*H):

137x27,8x160 cm

Shelves (L*W*H):

66,5x26x5 cm

Legs (L*W*H):

1x27x160 cm

Wall mounting:

We highly recommend attaching the cabinet to a solid supporting wall with the supplied assembly tools.

Please note!

Be careful with aggressive cleaning products, they could cause dull spots. Avoid sharp objects in the cabinet, to prevent scratches.

*All necessary mounting materials are included. Pay close attention to which items you need when you wish to expand the cabinet.

Colour options:

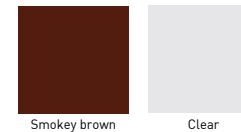

ACRYLIC CABINET 160 CM

For all possibilities and corresponding prices, please visit our website.

Combinations of elements (expansion examples)



MKA1994/MKA1995
Standing panel
160 cm



MKA1993
Back panel



MKA1997/MKA1998
Shelf

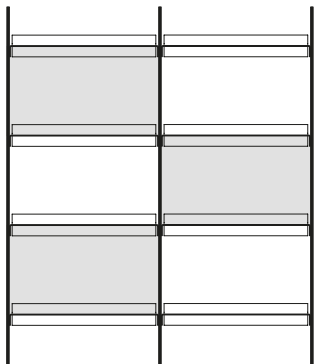

+



=

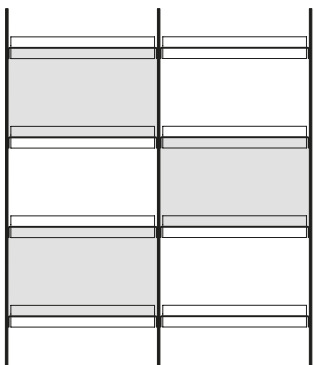
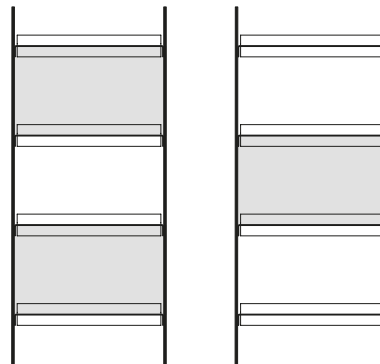

+

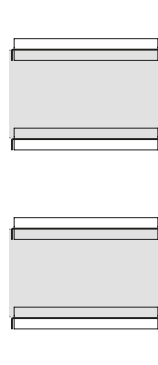

=

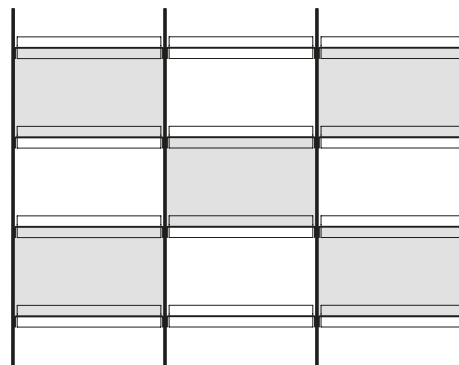

ACRYLIC CABINET 240 CM

Product fact sheet

For all possibilities and corresponding prices, please visit our website.

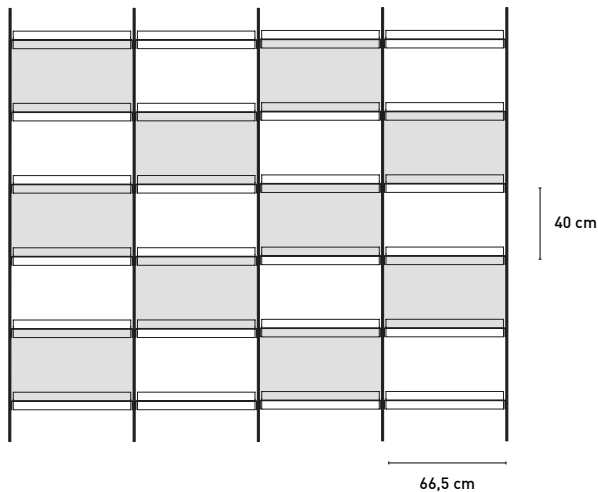

Acrylic Cabinet

Modular

See next page for modular options

Overall dimensions (L*W*H):

272,8x27,8x240 cm

Shelves (L*W*H):

66,5x26x5 cm

Legs (L*W*H):

1x27x240 cm

Wall mounting:

We highly recommend attaching the cabinet to a solid supporting wall with the supplied assembly tools.

Please note!

Be careful with aggressive cleaning products, they could cause dull spots. Avoid sharp objects in the cabinet, to prevent scratches.

*All necessary mounting materials are included. Pay close attention to which items you need when you wish to expand the cabinet.

Colour options:

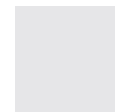

Clear

ACRYLIC CABINET 240 CM

For all possibilities and corresponding prices, please visit our website.

Combinations of elements (expansion examples)



MKA1996
Standing panel
240 cm

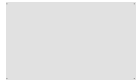

MKA1993
Back panel

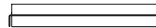

MKA1997
Shelf

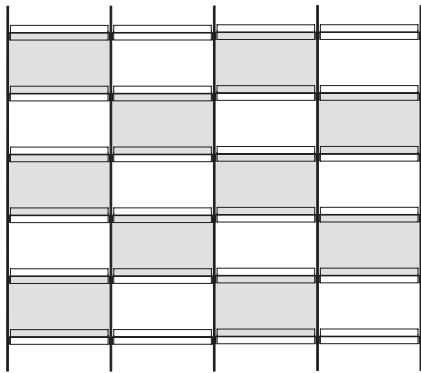

+



=

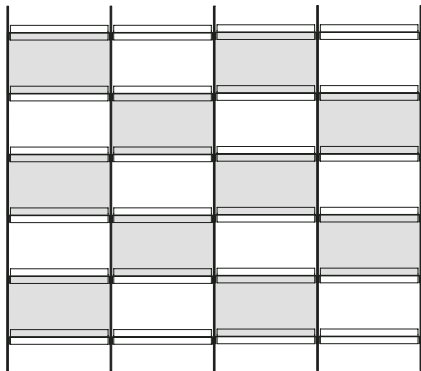
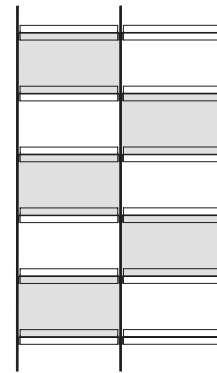
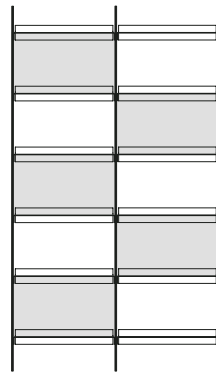

+

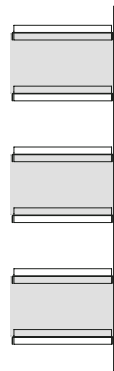

=

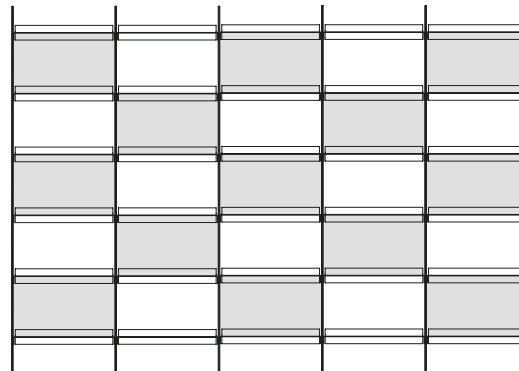



CLUB COUCH

Product fact sheet

For all possibilities and corresponding prices, please visit our website.

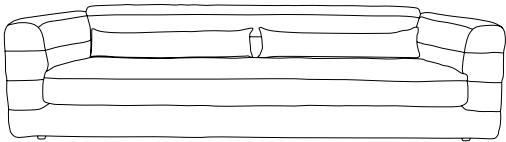

Club couch

4-seater

Overall dimensions (L*W*H):

274x108x72 cm

Back cushions:

2 cushions

Armrest height:

67 cm

Seat height:

46 cm

Seat depth:

65 cm

Seating width:

219 cm

FABRIC SPECIFICATIONS

For all possibilities and corresponding prices, please visit our website.

Royal velvet / Velvet / Linen blend / Linen shadow

Club couch

Royal velvet

Fabric group:

D (Royal)



Colours:

Green
Magnolia

Fabric covering specifications:

Composition faceside:	100% Polyester
Composition backing:	N/A
Coating:	Needle punch
Material weight:	518 g/lm
Tariff No.:	58013600
Abrasion resistance (EN ISO 12947 1 & 2):	40.000 cycles, Martindale
Pilling resistance (EN ISO 12945-2):	Class 4-5
Lightfastness (EN ISO B02):	Class 4-5

Filling and body:

Body:	Wood fiber board, pinewood, hardwood, hardboard
Seat suspension:	Nosag springs + polypropylene 70 g/m2
Seat filling:	HR 3032 foam covered with dacron cotton wool 150 g/m2
Back filling:	HR 3032 foam covered with dacron cotton wool 150 g/m2. Seperate back cushions: mix of silicone fibers and P40 (polypropylene).
Legs:	Black plastic

Club couch

Velvet

Fabric group:

D (Velvet)



Colours:

Mustard
Mint

Fabric covering specifications:

Composition faceside:	100% Polyester
Composition backing:	N/A
Coating:	Needle punch
Material weight:	470 g/lm
Tariff No.:	58013600
Abrasion resistance (EN ISO 12947 1 & 2):	80.000 cycles, Martindale
Pilling resistance (EN ISO 12945-2):	Class 4-5
Lightfastness (EN ISO B02):	Class 4-5

Filling and body:

Body:	Wood fiber board, pinewood, hardwood, hardboard
Seat suspension:	Nosag springs + polypropylene 70 g/m2
Seat filling:	HR 3032 foam covered with dacron cotton wool 150 g/m2
Back filling:	HR 3032 foam covered with dacron cotton wool 150 g/m2. Seperate back cushions: mix of silicone fibers and P40 (polypropylene).
Legs:	Black plastic

Club couch

Linen blend

Fabric group:

C (Linen blend)



Colours:

Taupe

Fabric covering specifications:

Composition faceside:	60% Cotton, 40% Linen
Composition backing:	N/A
Material weight:	532 g/lm
Tariff No.:	52122310
Abrasion resistance (EN ISO 12947 1 & 2):	24.000 cycles, Martindale
Pilling resistance (EN ISO 12945-2):	Class 4-5
Lightfastness (EN ISO B02):	Class 5

Filling and body:

Body:	Wood fiber board, pinewood, hardwood, hardboard
Seat suspension:	Nosag springs + polypropylene 70 g/m2
Seat filling:	HR 3032 foam covered with dacron cotton wool 150 g/m2
Back filling:	HR 3032 foam covered with dacron cotton wool 150 g/m2. Seperate back cushions: mix of silicone fibers and P40 (polypropylene).
Legs:	Black plastic

Care instructions:

Remove non-greasy stains by carefully dabbing with a lint-free cloth or sponge wrung out in clean warm water. If necessary, clean by dabbing with soapy water with a little dish soap. Finally, dab the surface with clean water. Avoid contact with sharp objects.

FABRIC SPECIFICATIONS

For all possibilities and corresponding prices, please visit our website.

Royal velvet / Velvet / Linen blend / Linen shadow

Club couch

Linen shadow

Fabric group:

D (Linen shadow)



Colours:

Brown

Fabric covering

specifications:

Composition faceside:	63% Cotton, 37% Linen
Composition backing:	N/A
Coating:	N/A
Material weight:	532 g/lm
Tariff No.:	52122310
Abrasion resistance (EN ISO 12947 1 & 2):	32.500 cycles, Martindale
Pilling resistance (EN ISO 12945-2):	Class 4
Lightfastness (EN ISO B02):	Class 4-5

Filling and body:

Body:	Wood fiber board, pinewood, hardwood, hardboard
Seat suspension:	Nosag springs + polypropylene 70 g/m ²
Seat filling:	HR 3032 foam covered with dacron cotton wool 150 g/m ²
Back filling:	HR 3032 foam covered with dacron cotton wool 150 g/m ² . Seperate back cushions: mix of silicone fibers and P40 (polypropylene).
Legs:	Black plastic

Care instructions:

Remove non-greasy stains by carefully dabbing with a lint-free cloth or sponge wrung out in clean warm water. If necessary, clean by dabbing with soapy water with a little dish soap. Finally, dab the surface with clean water. Avoid contact with sharp objects.



JAX COUCH

Product fact sheet

For all possibilities and corresponding prices, please visit our website.



Connecting parts

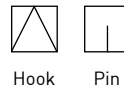

Hook Pin

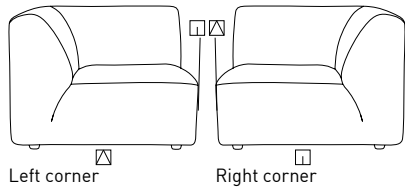

Jax couch
Element corner left and right

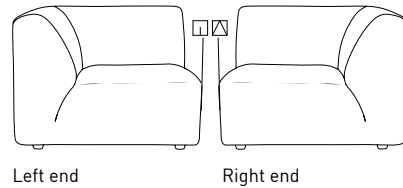

Jax couch
Element end left and right

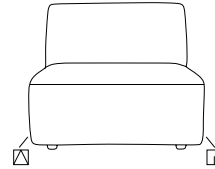

Jax couch
Element middle

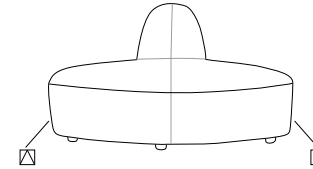

Jax couch
Element angle

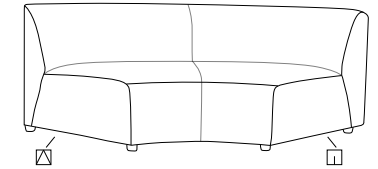

Jax couch
Element round

Overall dimensions (L/D*W*H):
94x94x74 cm

Combination options:
Can only be used as a corner piece

Armrest height:
74 cm

Seat height:
43 cm

Seat depth:
63 cm

Overall dimensions (L/D*W*H):
97x94x74 cm

Combination options:
Only to be used as an end element

Armrest height:
74 cm

Seat height:
43 cm

Seat depth:
65 cm

Overall dimensions (L/D*W*H):
97x87x74 cm

Combination options:
In any composition and sequence

Armrest height:
N/A

Seat height:
43 cm

Seat depth:
65 cm

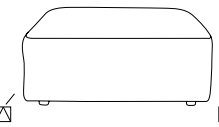

Jax couch
Element hocker

Overall dimensions (L/D*W*H):
97x94x43 cm

Combination options:
In any composition and sequence

Armrest height:
N/A

Seat height:
43 cm

Seat depth:
97 cm

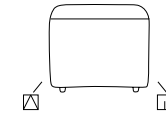

Jax couch
Element hocker small

Overall dimensions (L/D*W*H):
97x47x43 cm

Combination options:
In any composition and sequence

Armrest height:
N/A

Seat height:
43 cm

Seat depth:
97 cm

JAX COUCH

Combinations of elements

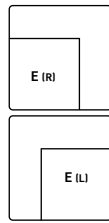
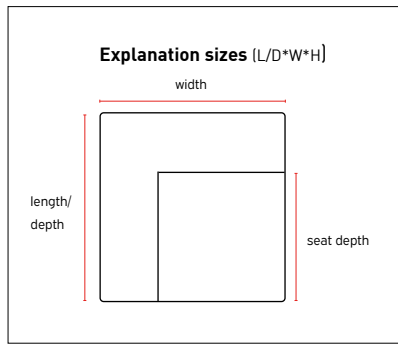

Jax couch
Element end
left and right

seat depth
65

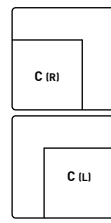

Jax couch
Element corner
left and right

seat depth
63

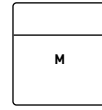

Jax couch
Element middle

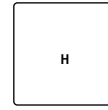

Jax couch
Element hocker

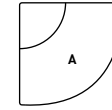

Jax couch
Element angle

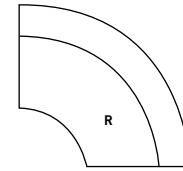

Jax couch
Element round

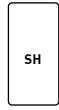

Jax couch
Element small hocker

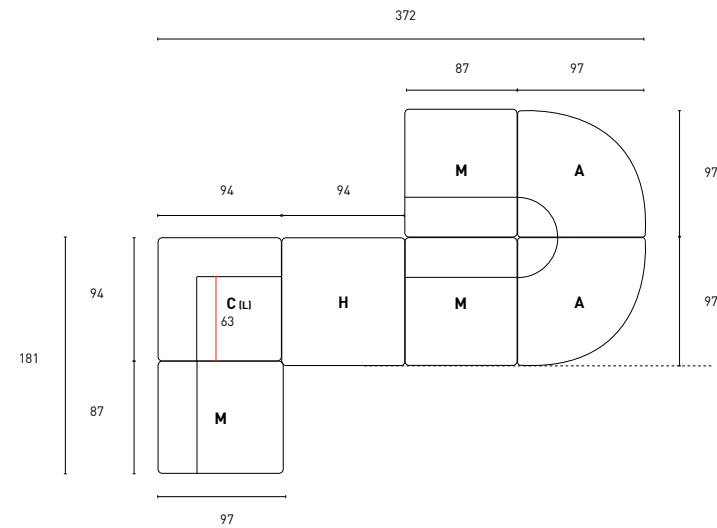
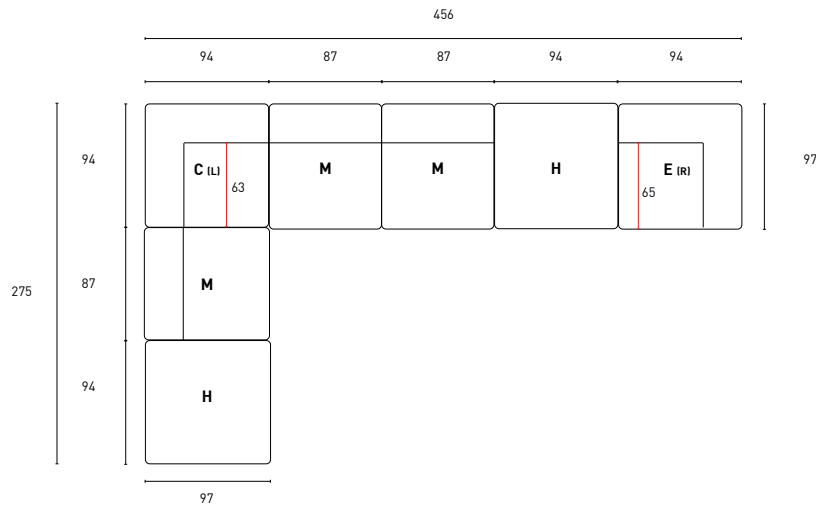
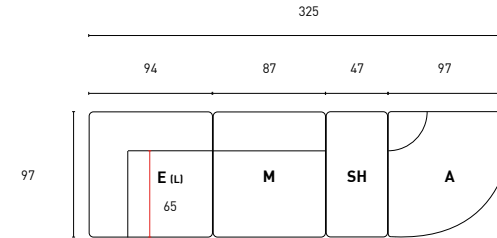
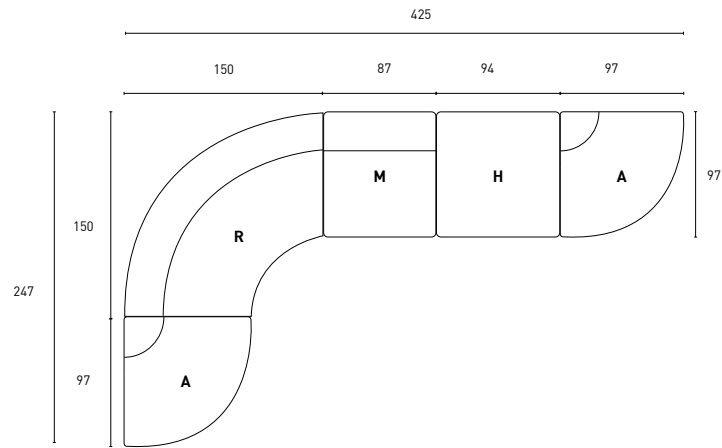

FABRIC SPECIFICATIONS

For all possibilities and corresponding prices, please visit our website.

Cosy / Sneak / Ted / Linen blend / Linen shadow / Royal velvet / Velvet / Boucle / Velvet juke

Jax couch

Cosy

Fabric group:

A (Cosy)



Colours:

Beige

Fabric covering specifications:

Product group: Polyester Polypropylen flatweave
Composition faceside: 61% Polyester 39% Polypropylen
Composition backing: N/A
Coating: Needle punch
Material weight: 440 g/lm
Tariff No.: 54077300
Abrasion resistance [EN ISO 12947 1 & 2]: 50.000 cycles, Martindale
Pilling resistance [EN ISO 12945-2]: Class 5, 2.000 Rubs
Lightfastness [EN ISO B02]: Class 4

Filling and body:

Body: Wood fiber board, pinewood, hardwood, hardboard
Seat suspension: Nosag springs
Seat filling: HR 3032 foam + SG25 foam covered with dacron cotton wool 150 g/m2
Back filling: SG1818 foam
Legs: Black plastic

Jax couch

Ted

Fabric group:

B (Ted)



Colours:

Stone

Fabric covering specifications:

Composition faceside: 100% Polyester
Composition backing: N/A
Coating: Needle punch
Material weight: 518 g/lm
Tariff No.: 58013600
Abrasion resistance [EN ISO 12947 1 & 2]: 40.000 cycles, Martindale
Pilling resistance [EN ISO 12945-2]: Class 4
Lightfastness [EN ISO B02]: Class 5

Filling and body:

Body: Wood fiber board, pinewood, hardwood, hardboard
Seat suspension: Nosag springs
Seat filling: HR 3032 foam + SG25 foam covered with dacron cotton wool 150 g/m2
Back filling: SG1818 foam
Legs: Black plastic

Jax couch

Sneak

Fabric group:

B (Sneak)



Colours:

Light grey

Fabric covering specifications:

Product group: Chenille flatweave
Composition faceside: 100% Polyester
Composition backing: N/A
Coating: Needle punch
Material weight: 518 g/lm
Tariff No.: 58013600
Abrasion resistance [EN ISO 12947 1 & 2]: 38.000 cycles, Martindale
Pilling resistance [EN ISO 12945-2]: Class 5, 2.000 Rubs
Lightfastness [EN ISO B02]: Class 4-5

Filling and body:

Body: Wood fiber board, pinewood, hardwood, hardboard
Seat suspension: Nosag springs
Seat filling: HR 3032 foam + SG25 foam covered with dacron cotton wool 150 g/m2
Back filling: SG1818 foam
Legs: Black plastic

Care instructions:

Remove non-greasy stains by carefully dabbing with a lint-free cloth or sponge wrung out in clean warm water. If necessary, clean by dabbing with soapy water with a little dish soap. Finally, dab the surface with clean water. Avoid contact with sharp objects.

FABRIC SPECIFICATIONS

For all possibilities and corresponding prices, please visit our website.

Cosy / Sneak / Ted / Linen blend / Linen shadow / Royal velvet / Velvet / Boucle / Velvet juke

Jax couch

Boucle

Fabric group:

B (Boucle)

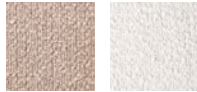

Colours:

Taupe
Cream

Fabric covering specifications:

Composition faceside:	95% Polyester, 5% Polyamide
Composition backing:	N/A
Coating:	N/A
Material weight:	600 g/lm
Tariff No.:	512110000
Abrasion resistance (EN ISO 12947 1 & 2):	100.000 cycles, Martindale
Pilling resistance (EN ISO 12945-2):	Class 4
Lightfastness (EN ISO B02):	Class 5

Filling and body:

Body:	Wood fiber board, pinewood, hardwood, hardboard
Seat suspension:	Nosag springs
Seat filling:	HR 3032 foam + SG25 foam covered with dacron cotton wool 150 g/m2
Back filling:	SG1818 foam
Legs:	Black plastic

Jax couch

Linen shadow

Fabric group:

D (Linen shadow)



Colours:

Brown

Fabric covering specifications:

Composition faceside:	63% Cotton, 37% Linen
Composition backing:	N/A
Coating:	N/A
Material weight:	532 g/lm
Tariff No.:	52122310
Abrasion resistance (EN ISO 12947 1 & 2):	32.500 cycles, Martindale
Pilling resistance (EN ISO 12945-2):	Class 4
Lightfastness (EN ISO B02):	Class 4-5

Filling and body:

Body:	Wood fiber board, pinewood, hardwood, hardboard
Seat suspension:	Nosag springs
Seat filling:	HR 3032 foam + SG25 foam covered with dacron cotton wool 150 g/m2
Back filling:	SG1818 foam
Legs:	Black plastic

Jax couch

Linen blend

Fabric group:

C (Linen blend)



Colours:

Taupe

Fabric covering specifications:

Composition faceside:	60% Cotton, 40% Linen
Composition backing:	N/A
Material weight:	532 g/lm
Tariff No.:	52122310
Abrasion resistance (EN ISO 12947 1 & 2):	24.000 cycles, Martindale
Pilling resistance (EN ISO 12945-2):	Class 4-5
Lightfastness (EN ISO B02):	Class 5

Filling and body:

Body:	Wood fiber board, pinewood, hardwood, hardboard
Seat suspension:	Nosag springs
Seat filling:	HR 3032 foam + SG25 foam covered with dacron cotton wool 150 g/m2
Back filling:	SG1818 foam
Legs:	Black plastic

Care instructions:

Remove non-greasy stains by carefully dabbing with a lint-free cloth or sponge wrung out in clean warm water. If necessary, clean by dabbing with soapy water with a little dish soap. Finally, dab the surface with clean water. Avoid contact with sharp objects.

FABRIC SPECIFICATIONS

For all possibilities and corresponding prices, please visit our website.

Cosy / Sneak / Ted / Linen blend / Linen shadow / Royal velvet / Velvet / Boucle / Velvet juke

Jax couch

Velvet Juke

Fabric group:

B (Juke)



Colours:

Ochre

Fabric covering

specifications:

Product group:	Polyester velvet knitted
Composition faceside:	100% Polyester
Composition backing:	90% Polyester, 10% Cotton
Bonding:	T/C
Material weight:	560 g/lm
Tariff No.:	60019200
Abrasion resistance (EN ISO 12947 1 & 2):	100.000 cycles, Martindale
Pilling resistance (EN ISO 12945-2):	Class 5, 2.000 Rubs
Lightfastness (EN ISO B02):	Class 4-5

Filling and body:

Body:	Wood fiber board, pinewood, hardwood, hardboard
Seat suspension:	Nosag springs
Seat filling:	HR 3032 foam + SG25 foam covered with dacron cotton wool 150 g/m2
Back filling:	SG1818 foam
Legs:	Black plastic

Jax couch

Royal velvet

Fabric group:

D (Royal)



Colours:

Magnolia

Green

Fabric covering

specifications:

Composition faceside:	100% Polyester
Composition backing:	N/A
Coating:	Needle punch
Material weight:	518 g/lm
Tariff No.:	58013600
Abrasion resistance (EN ISO 12947 1 & 2):	40.000 cycles, Martindale
Pilling resistance (EN ISO 12945-2):	Class 4-5
Lightfastness (EN ISO B02):	Class 4-5

Filling and body:

Body:	Wood fiber board, pinewood, hardwood, hardboard
Seat suspension:	Nosag springs
Seat filling:	HR 3032 foam + SG25 foam covered with dacron cotton wool 150 g/m2
Back filling:	SG1818 foam
Legs:	Black plastic

Jax couch

Velvet

Fabric group:

D (Velvet)



Colours:

Mustard

Mint

Fabric covering

specifications:

Composition faceside:	100% Polyester
Composition backing:	N/A
Coating:	Needle punch
Material weight:	470 g/lm
Tariff No.:	58013600
Abrasion resistance (EN ISO 12947 1 & 2):	80.000 cycles, Martindale
Pilling resistance (EN ISO 12945-2):	Class 4-5
Lightfastness (EN ISO B02):	Class 4-5

Filling and body:

Body:	Wood fiber board, pinewood, hardwood, hardboard
Seat suspension:	Nosag springs
Seat filling:	HR 3032 foam + SG25 foam covered with dacron cotton wool 150 g/m2
Back filling:	SG1818 foam
Legs:	Black plastic

Care instructions:

Remove non-greasy stains by carefully dabbing with a lint-free cloth or sponge wrung out in clean warm water. If necessary, clean by dabbing with soapy water with a little dish soap. Finally, dab the surface with clean water. Avoid contact with sharp objects.



RETRO SOFA

Product fact sheet

For all possibilities and corresponding prices, please visit our website.

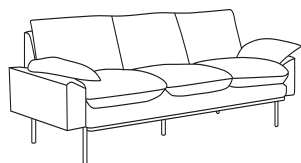

Retro sofa

4-seater

Overall dimensions (L*W*H):

245x95x83 cm

Seat cushions:

3 cushions, 70x63 cm

Armrest height:

50 cm

Seat height:

46 cm

Seat depth:

63 cm

Legs:

23 cm

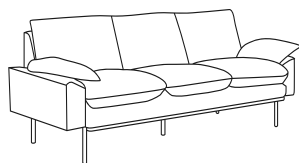

Retro sofa

3-seater

Overall dimensions (L*W*H):

225x95x83 cm

Seat cushions:

3 cushions, 63x63 cm

Armrest height:

50 cm

Seat height:

46 cm

Seat depth:

63 cm

Legs:

23 cm

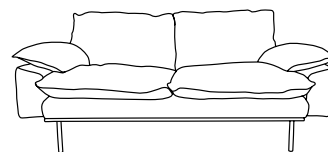

Retro sofa

2-seater

Overall dimensions (L*W*H):

175x95x83 cm

Seat cushions:

2 cushions, 70x63 cm

Armrest height:

50 cm

Seat height:

46 cm

Seat depth:

63 cm

Legs:

23 cm

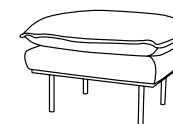

Retro sofa

Hocker

Overall dimensions (L*W*H):

72x63x46 cm

Seat cushions:

1 cushion, 63x63 cm

Armrest height:

N/A

Seat height:

N/A

Seat depth:

N/A

Legs:

23 cm

FABRIC SPECIFICATIONS

For all possibilities and corresponding prices, please visit our website.

Corduroy rib / Cosy / Corduroy velvet / Sneak / Ted / Linen blend / Linen shadow / Royal velvet / Velvet / Boucle / Velvet juke

Retro sofa

Cosy

Fabric group:

A (Cosy)



Colours:

Beige

Fabric covering specifications:

Product group:	Polyester Polypropyleen flatweave
Composition faceside:	61% Polyester, 39% Polypropyleen
Composition backing:	N/A
Coating:	Needle punch
Material weight:	440 g/lm
Tariff No.:	54077300
Abrasion resistance (EN ISO 12947 1 & 2):	50.000 cycles, Martindale
Pilling resistance (EN ISO 12945-2):	Class 5, 2.000 Rubs
Lightfastness (EN ISO B02):	Class 4-5

Filling and body:

Body:	Wood fiber board, hardwood, hardboard
Seat suspension:	Nosag springs
Seat filling:	HR 3032 foam + feathers & memory foam flakes mix
Back filling:	Mix of feathers & memory foam flakes
Legs:	Black powder coated metal

Retro sofa

Ted

Fabric group:

B (Ted)



Colours:

Stone

Fabric covering specifications:

Product group:	100% Polyester
Composition faceside:	100% Polyester
Composition backing:	N/A
Coating:	Needle punch
Material weight:	518 g/lm
Tariff No.:	58013600
Abrasion resistance (EN ISO 12947 1 & 2):	40.000 cycles, Martindale
Pilling resistance (EN ISO 12945-2):	Class 4
Lightfastness (EN ISO B02):	Class 5

Filling and body:

Body:	Wood fiber board, hardwood, hardboard
Seat suspension:	Nosag springs
Seat filling:	HR 3032 foam + feathers & memory foam flakes mix
Back filling:	Mix of feathers & memory foam flakes
Legs:	Black powder coated metal

Retro sofa

Sneak

Fabric group:

B (Sneak)



Colours:

Light grey

Fabric covering specifications:

Product group:	Chenille flatweave
Composition faceside:	100% Polyester
Composition backing:	N/A
Coating:	Needle punch
Material weight:	518 g/lm
Tariff No.:	58013600
Abrasion resistance (EN ISO 12947 1 & 2):	38.000 cycles, Martindale
Pilling resistance (EN ISO 12945-2):	Class 5, 2.000 Rubs
Lightfastness (EN ISO B02):	Class 4-5

Filling and body:

Body:	Wood fiber board, hardwood, hardboard
Seat suspension:	Nosag springs
Seat filling:	HR 3032 foam + feathers & memory foam flakes mix
Back filling:	Mix of feathers & memory foam flakes
Legs:	Black powder coated metal

Care instructions:

Remove non-greasy stains by carefully dabbing with a lint-free cloth or sponge wrung out in clean warm water. If necessary, clean by dabbing with soapy water with a little dish soap. Finally, dab the surface with clean water. Avoid contact with sharp objects.

FABRIC SPECIFICATIONS

For all possibilities and corresponding prices, please visit our website.

Corduroy rib / Cosy / Corduroy velvet / Sneak / Ted / Linen blend / Linen shadow / Royal velvet / Velvet / Boucle / Velvet juke

Retro sofa

Boucle

Fabric group:

B (Boucle)

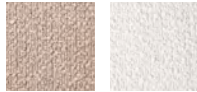

Colours:

Taupe
Cream

Fabric covering specifications:

Composition faceside: 95% Polyester, 5% Polyamide
Composition backing: N/A
Coating: N/A
Material weight: 600 g/lm
Tariff No.: 512110000
Abrasion resistance (EN ISO 12947 1 & 2): 100.000 cycles, Martindale
Pilling resistance (EN ISO 12945-2): Class 4
Lightfastness (EN ISO B02): Class 5

Filling and body:

Body: Wood fiber board, hardwood, hardboard
Seat suspension: Nosag springs
Seat filling: HR 3032 foam + feathers & memory foam flakes mix
Back filling: Mix of feathers & memory foam flakes
Legs: Black powder coated metal

Retro sofa

Linen shadow

Fabric group:

D (Linen shadow)



Colours:

Brown

Fabric covering specifications:

Composition faceside: 63% Cotton, 37% Linen
Composition backing: N/A
Coating: N/A
Material weight: 532 g/lm
Tariff No.: 52122310
Abrasion resistance (EN ISO 12947 1 & 2): 32.500 cycles, Martindale
Pilling resistance (EN ISO 12945-2): Class 4
Lightfastness (EN ISO B02): Class 4-5

Filling and body:

Body: Wood fiber board, hardwood, hardboard
Seat suspension: Nosag springs
Seat filling: HR 3032 foam + feathers & memory foam flakes mix
Back filling: Mix of feathers & memory foam flakes
Legs: Black powder coated metal

Retro sofa

Linen blend

Fabric group:

C (Linen blend)



Colours:

Taupe

Fabric covering specifications:

Composition faceside: 60% Cotton, 40% Linen
Composition backing: N/A
Material weight: 532 g/lm
Tariff No.: 52122310
Abrasion resistance (EN ISO 12947 1 & 2): 24.000 cycles, Martindale
Pilling resistance (EN ISO 12945-2): Class 4-5
Lightfastness (EN ISO B02): Class 5

Filling and body:

Body: Wood fiber board, hardwood, hardboard
Seat suspension: Nosag springs
Seat filling: HR 3032 foam + feathers & memory foam flakes mix
Back filling: Mix of feathers & memory foam flakes
Legs: Black powder coated metal

Care instructions:

Remove non-greasy stains by carefully dabbing with a lint-free cloth or sponge wrung out in clean warm water. If necessary, clean by dabbing with soapy water with a little dish soap. Finally, dab the surface with clean water. Avoid contact with sharp objects.

FABRIC SPECIFICATIONS

For all possibilities and corresponding prices, please visit our website.

Corduroy rib / Cosy / Corduroy velvet / Sneak / Ted / Linen blend / Linen shadow / Royal velvet / Velvet / Boucle / Velvet juke

Retro sofa

Velvet Juke

Fabric group:

B (Juke)



Colours:

Ochre

Fabric covering

specifications:

Product group:	Polyester velvet knitted
Composition faceside:	100% Polyester
Composition backing:	90% Polyester. 10% Cotton
Bonding:	T/C
Material weight:	560 g/lm
Tariff No.:	60019200
Abrasion resistance (EN ISO 12947 1 & 2):	100.000 cycles, Martindale
Pilling resistance (EN ISO 12945-2):	Class 5, 2.000 Rubs
Lightfastness (EN ISO B02):	Class 4-5

Filling and body:

Body:	Wood fiber board, hardwood, hardboard
Seat suspension:	Nosag springs
Seat filling:	HR 3032 foam + feathers & memory foam flakes mix
Back filling:	Mix of feathers & memory foam flakes
Legs:	Black powder coated metal

Retro sofa

Royal velvet

Fabric group:

D (Royal)



Colours:

Magnolia

Green

Fabric covering

specifications:

Composition faceside:	100% Polyester
Composition backing:	N/A
Coating:	Needle punch
Material weight:	518 g/lm
Tariff No.:	58013600
Abrasion resistance (EN ISO 12947 1 & 2):	40.000 cycles, Martindale
Pilling resistance (EN ISO 12945-2):	Class 4-5
Lightfastness (EN ISO B02):	Class 4-5

Filling and body:

Body:	Wood fiber board, hardwood, hardboard
Seat suspension:	Nosag springs
Seat filling:	HR 3032 foam + feathers & memory foam flakes mix
Back filling:	Mix of feathers & memory foam flakes
Legs:	Black powder coated metal

Retro sofa

Velvet

Fabric group:

D (Velvet)



Colours:

Mustard

Mint

Fabric covering

specifications:

Composition faceside:	100% Polyester
Composition backing:	N/A
Coating:	Needle punch
Material weight:	470 g/lm
Tariff No.:	58013600
Abrasion resistance (EN ISO 12947 1 & 2):	80.000 cycles, Martindale
Pilling resistance (EN ISO 12945-2):	Class 4-5
Lightfastness (EN ISO B02):	Class 4-5

Filling and body:

Body:	Wood fiber board, hardwood, hardboard
Seat suspension:	Nosag springs
Seat filling:	HR 3032 foam + feathers & memory foam flakes mix
Back filling:	Mix of feathers & memory foam flakes
Legs:	Black powder coated metal

Care instructions:

Remove non-greasy stains by carefully dabbing with a lint-free cloth or sponge wrung out in clean warm water. If necessary, clean by dabbing with soapy water with a little dish soap. Finally, dab the surface with clean water. Avoid contact with sharp objects.

FABRIC SPECIFICATIONS

For all possibilities and corresponding prices, please visit our website.

Corduroy rib / Cosy / Corduroy velvet / Sneak / Ted / Linen blend / Linen shadow / Royal velvet / Velvet / Boucle / Velvet juke

Retro sofa

Corduroy rib

Fabric group:

A (Wave)

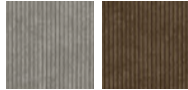

Colours:

Cream
Brown

Fabric covering specifications:

Covering composition: 92% Polyester, 8% Nylon
Bonding: Polyester/Polyamide
Material weight: 300 g/lm
Tariff No.: 8501320000
Abrasion resistance
[EN ISO 12947 1 & 2]: 40.000 cycles, Martindale
Pilling resistance
[EN ISO 12945-2]: Class 4, 2.000 Rubs
Lightfastness
[EN ISO B02]: Class 4

Filling and body:

Body: Wood fiber board, hardwood,
hardboard
Seat suspension: Nosag springs
Seat filling: HR 3032 foam + feathers & memory
foam flakes mix
Back filling: Mix of feathers & memory foam flakes
Legs: Black powder coated metal

Retro sofa

Corduroy velvet

Fabric group:

B (Corduroy rib velvet)



Colours:

Aged gold

Fabric covering specifications:

Covering composition: 100% Polyester
Bonding: T/C
Material weight: 580 g/lm
Tariff No.: 60053700
Abrasion resistance
[EN ISO 12947 1 & 2]: 55.000 cycles, Martindale
Pilling resistance
[EN ISO 12945-2]: Class 5, 2.000 Rubs
Lightfastness
[EN ISO B02]: Class 4-5

Filling and body:

Body: Wood fiber board, hardwood,
hardboard
Seat suspension: Nosag springs
Seat filling: HR 3032 foam + feathers & memory
foam flakes mix
Back filling: Mix of feathers & memory foam flakes
Legs: Black powder coated metal

Care instructions:

Remove non-greasy stains by carefully dabbing with a lint-free cloth or sponge wrung out in clean warm water. If necessary, clean by dabbing with soapy water with a little dish soap. Finally, dab the surface with clean water. Avoid contact with sharp objects.



VINT COUCH

Product fact sheet

For all possibilities and corresponding prices, please visit our website.



Connecting parts

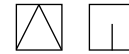

Hook



Pin

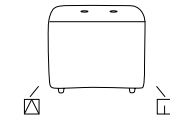
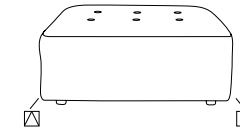
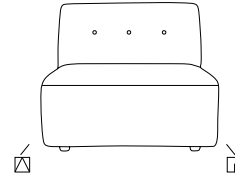
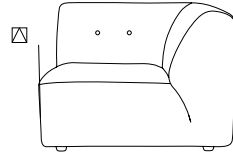
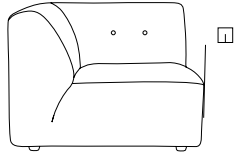

Vint couch

Element left

Overall dimensions (L/D*W*H):

97x94x74 cm

Combination options:

Only as a left end element

Armrest height:

74 cm

Seat height:

43 cm

Seat depth:

65 cm

Vint couch

Element right

Overall dimensions (L/D*W*H):

97x94x74 cm

Combination options:

Only as a right end element

Armrest height:

74 cm

Seat height:

43 cm

Seat depth:

65 cm

Vint couch

Element middle

Overall dimensions (L/D*W*H):

97x87x74 cm

Combination options:

In any composition and sequence

Armrest height:

N/A

Seat height:

43 cm

Seat depth:

65 cm

Vint couch

Element hocker

Overall dimensions (L/D*W*H):

97x94x43 cm

Combination options:

In any composition and sequence

Armrest height:

N/A

Seat height:

43 cm

Seat depth:

94 cm

Vint couch

Element hocker small

Overall dimensions (L/D*W*H):

97x47x43 cm

Combination options:

In any composition and sequence

Armrest height:

N/A

Seat height:

43 cm

Seat depth:

94 cm

VINT COUCH

Product fact sheet



Connecting parts

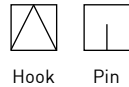

Hook Pin

For all possibilities and corresponding prices, please visit our website.

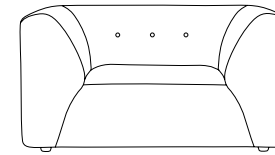

Vint couch

Element loveseat

Overall dimensions (L/D*W*H):

97x148x74 cm

Armrest height:

74 cm

Seat height:

43 cm

Seat depth:

65 cm

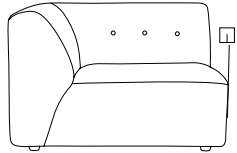

Vint couch

Element left 1,5 seat

Overall dimensions (L/D*W*H):

97x118x74 cm

Combination options:

Only as a left end element

Armrest height:

74 cm

Seat height:

43 cm

Seat depth:

65 cm

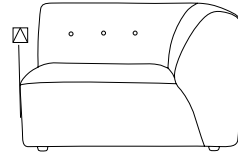

Vint couch

Element right 1,5 seat

Overall dimensions (L/D*W*H):

97x118x74 cm

Combination options:

Only as a right end element

Armrest height:

74 cm

Seat height:

43 cm

Seat depth:

65 cm

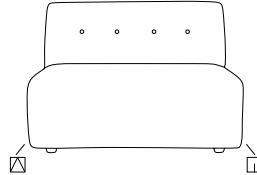

Vint couch

Element middle 1,5 seat

Overall dimensions (L/D*W*H):

97x104x74 cm

Combination options:

In any composition and sequence

Armrest height:

N/A

Seat height:

43 cm

Seat depth:

65 cm

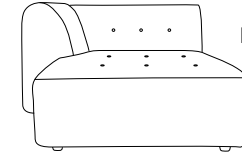

Vint couch

Element left divan

Overall dimensions (L/D*W*H):

160x118x74 cm

Combination options:

Only to be used as an end element

Armrest height:

74 cm

Seat height:

43 cm

Seat depth:

128 cm

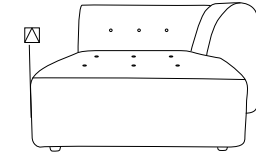

Vint couch

Element right divan

Overall dimensions (L/D*W*H):

160x118x74 cm

Combination options:

Only to be used as an end element

Armrest height:

74 cm

Seat height:

43 cm

Seat depth:

128 cm

VINT COUCH

Combine your couch - inspiration

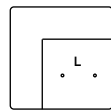
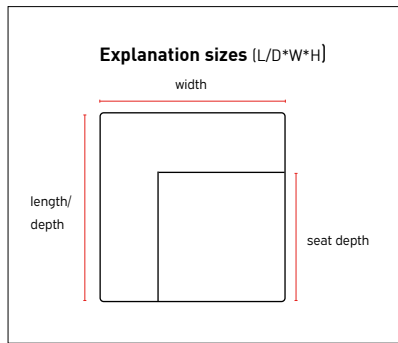

Vint couch
Element left

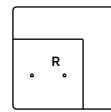

Vint couch
Element right

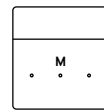

Vint couch
Element middle

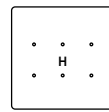

Vint couch
Element hocker

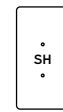

Vint couch
Element hocker small

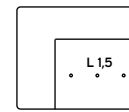

Vint couch
Element left 1,5 seat

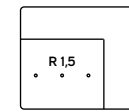

Vint couch
Element right 1,5 seat

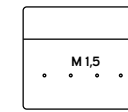

Vint couch
Element middle 1,5 seat

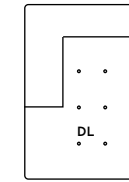

Vint couch
Element divan left

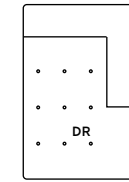

Vint couch
Element divan right

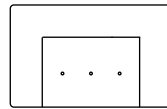

Vint couch
Element loveseat

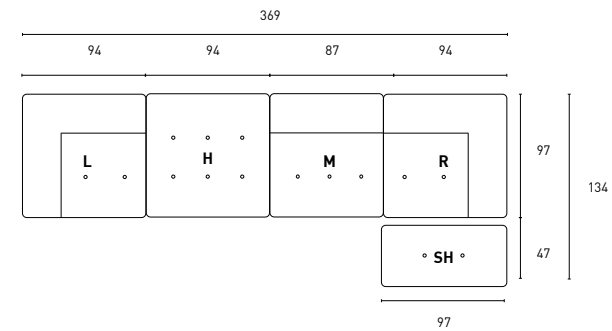
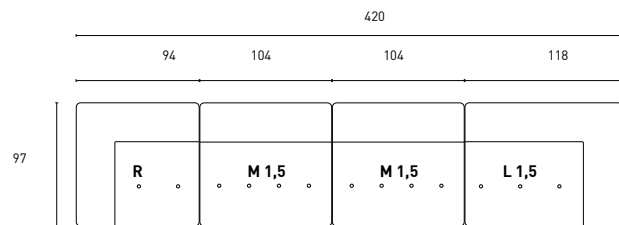
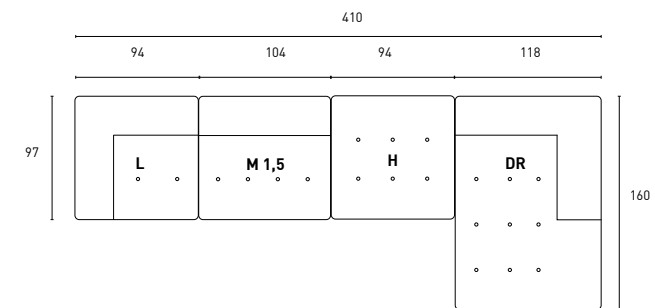
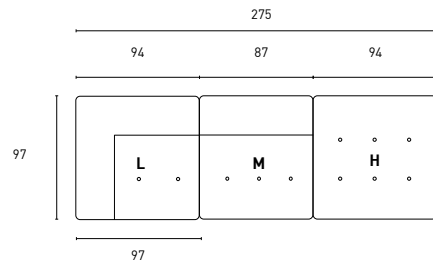

FABRIC SPECIFICATIONS

For all possibilities and corresponding prices, please visit our website.

Corduroy rib / Cosy / Corduroy velvet / Sneak / Ted / Linen blend / Linen shadow / Royal velvet / Velvet / Boucle / Velvet juke

Vint couch

Cosy

Fabric group:

A (Cosy)



Colours:

Beige

Fabric covering specifications:

Product group:	Polyester Polypropyleen flatweave
Composition faceside:	61% Polyester, 39% Polypropyleen
Composition backing:	N/A
Coating:	Needle punch
Material weight:	440 g/lm
Tariff No.:	54077300
Abrasion resistance (EN ISO 12947 1 & 2):	50.000 cycles, Martindale
Pilling resistance (EN ISO 12945-2):	Class 5, 2.000 Rubs
Lightfastness (EN ISO B02):	Class 4-5

Filling and body:

Body:	Wood fiber board, pinewood, hardwood, hardboard
Seat suspension:	Nosag springs
Seat filling:	HR 3032 foam + SG25 foam covered with dacron cotton wool 150 g/m2
Back filling:	SG1818 foam
Legs:	Black plastic

Vint couch

Ted

Fabric group:

B (Ted)



Colours:

Stone

Fabric covering specifications:

Composition faceside:	100% Polyester
Composition backing:	N/A
Coating:	Needle punch
Material weight:	518 g/lm
Tariff No.:	58013600
Abrasion resistance (EN ISO 12947 1 & 2):	40.000 cycles, Martindale
Pilling resistance (EN ISO 12945-2):	Class 4
Lightfastness (EN ISO B02):	Class 5

Filling and body:

Body:	Wood fiber board, pinewood, hardwood, hardboard
Seat suspension:	Nosag springs
Seat filling:	HR 3032 foam + SG25 foam covered with dacron cotton wool 150 g/m2
Back filling:	SG1818 foam
Legs:	Black plastic

Vint couch

Sneak

Fabric group:

B (Sneak)



Colours:

Light grey

Fabric covering specifications:

Product group:	Chenille flatweave
Composition faceside:	100% Polyester
Composition backing:	N/A
Coating:	Needle punch
Material weight:	518 g/lm
Tariff No.:	58013600
Abrasion resistance (EN ISO 12947 1 & 2):	38.000 cycles, Martindale
Pilling resistance (EN ISO 12945-2):	Class 5, 2.000 Rubs
Lightfastness (EN ISO B02):	Class 4-5

Filling and body:

Body:	Wood fiber board, pinewood, hardwood, hardboard
Seat suspension:	Nosag springs
Seat filling:	HR 3032 foam + SG25 foam covered with dacron cotton wool 150 g/m2
Back filling:	SG1818 foam
Legs:	Black plastic

Care instructions:

Remove non-greasy stains by carefully dabbing with a lint-free cloth or sponge wrung out in clean warm water. If necessary, clean by dabbing with soapy water with a little dish soap. Finally, dab the surface with clean water. Avoid contact with sharp objects.

FABRIC SPECIFICATIONS

For all possibilities and corresponding prices, please visit our website.

Corduroy rib / Cosy / Corduroy velvet / Sneak / Ted / Linen blend / Linen shadow / Royal velvet / Velvet / Boucle / Velvet juke

Vint couch

Boucle

Fabric group:

B (Boucle)



Colours:

Taupe
Cream

Fabric covering specifications:

Composition faceside:	95% Polyester, 5% Polyamide
Composition backing:	N/A
Coating:	N/A
Material weight:	600 g/lm
Tariff No.:	512110000
Abrasion resistance (EN ISO 12947 1 & 2):	100.000 cycles, Martindale
Pilling resistance (EN ISO 12945-2):	Class 4
Lightfastness (EN ISO B02):	Class 5

Filling and body:

Body:	Wood fiber board, pinewood, hardwood, hardboard
Seat suspension:	Nosag springs
Seat filling:	HR 3032 foam + SG25 foam covered with dacron cotton wool 150 g/m2
Back filling:	SG1818 foam
Legs:	Black plastic

Vint couch

Linen shadow

Fabric group:

D (Linen shadow)



Colours:

Brown

Fabric covering specifications:

Composition faceside:	63% Cotton, 37% Linen
Composition backing:	N/A
Coating:	N/A
Material weight:	532 g/lm
Tariff No.:	52122310
Abrasion resistance (EN ISO 12947 1 & 2):	32.500 cycles, Martindale
Pilling resistance (EN ISO 12945-2):	Class 4
Lightfastness (EN ISO B02):	Class 4-5

Filling and body:

Body:	Wood fiber board, pinewood, hardwood, hardboard
Seat suspension:	Nosag springs
Seat filling:	HR 3032 foam + SG25 foam covered with dacron cotton wool 150 g/m2
Back filling:	SG1818 foam
Legs:	Black plastic

Vint couch

Linen blend

Fabric group:

C (Linen blend)



Colours:

Taupe

Fabric covering specifications:

Composition faceside:	60% Cotton, 40% Linen
Composition backing:	N/A
Material weight:	532 g/lm
Tariff No.:	52122310
Abrasion resistance (EN ISO 12947 1 & 2):	24.000 cycles, Martindale
Pilling resistance (EN ISO 12945-2):	Class 4-5
Lightfastness (EN ISO B02):	Class 5

Filling and body:

Body:	Wood fiber board, pinewood, hardwood, hardboard
Seat suspension:	Nosag springs
Seat filling:	HR 3032 foam + SG25 foam covered with dacron cotton wool 150 g/m2
Back filling:	SG1818 foam
Legs:	Black plastic

Care instructions:

Remove non-greasy stains by carefully dabbing with a lint-free cloth or sponge wrung out in clean warm water. If necessary, clean by dabbing with soapy water with a little dish soap. Finally, dab the surface with clean water. Avoid contact with sharp objects.

FABRIC SPECIFICATIONS

For all possibilities and corresponding prices, please visit our website.

Corduroy rib / Cosy / Corduroy velvet / Sneak / Ted / Linen blend / Linen shadow / Royal velvet / Velvet / Boucle / Velvet juke

Vint couch

Velvet Juke

Fabric group:

B (Juke)



Colours:

Ochre

Fabric covering specifications:

Product group:	Polyester velvet knitted
Composition faceside:	100% Polyester
Composition backing:	90% Polyester, 10% Cotton
Bonding:	T/C
Material weight:	560 g/lm
Tariff No.:	60019200
Abrasion resistance (EN ISO 12947 1 & 2):	100.000 cycles, Martindale
Pilling resistance (EN ISO 12945-2):	Class 5, 2.000 Rubs
Lightfastness (EN ISO B02):	Class 4-5

Filling and body:

Body:	Wood fiber board, pinewood, hardwood, hardboard
Seat suspension:	Nosag springs
Seat filling:	HR 3032 foam + SG25 foam covered with dacron cotton wool 150 g/m2
Back filling:	SG1818 foam
Legs:	Black plastic

Vint couch

Royal velvet

Fabric group:

D (Royal)



Colours:

Magnolia
Green

Fabric covering specifications:

Composition faceside:	100% Polyester
Composition backing:	N/A
Coating:	Needle punch
Material weight:	518 g/lm
Tariff No.:	58013600
Abrasion resistance (EN ISO 12947 1 & 2):	40.000 cycles, Martindale
Pilling resistance (EN ISO 12945-2):	Class 4-5
Lightfastness (EN ISO B02):	Class 4-5

Filling and body:

Body:	Wood fiber board, pinewood, hardwood, hardboard
Seat suspension:	Nosag springs
Seat filling:	HR 3032 foam + SG25 foam covered with dacron cotton wool 150 g/m2
Back filling:	SG1818 foam
Legs:	Black plastic

Vint couch

Velvet

Fabric group:

D (Velvet)



Colours:

Mustard
Mint

Fabric covering specifications:

Composition faceside:	100% Polyester
Composition backing:	N/A
Coating:	Needle punch
Material weight:	470 g/lm
Tariff No.:	58013600
Abrasion resistance (EN ISO 12947 1 & 2):	80.000 cycles, Martindale
Pilling resistance (EN ISO 12945-2):	Class 4-5
Lightfastness (EN ISO B02):	Class 4-5

Filling and body:

Body:	Wood fiber board, pinewood, hardwood, hardboard
Seat suspension:	Nosag springs
Seat filling:	HR 3032 foam + SG25 foam covered with dacron cotton wool 150 g/m2
Back filling:	SG1818 foam
Legs:	Black plastic

Care instructions:

Remove non-greasy stains by carefully dabbing with a lint-free cloth or sponge wrung out in clean warm water. If necessary, clean by dabbing with soapy water with a little dish soap. Finally, dab the surface with clean water. Avoid contact with sharp objects.

FABRIC SPECIFICATIONS

For all possibilities and corresponding prices, please visit our website.

Corduroy rib / Cosy / Corduroy velvet / Sneak / Ted / Linen blend / Linen shadow / Royal velvet / Velvet / Boucle / Velvet juke

Vint couch

Corduroy rib

Fabric group:

A (Wave)

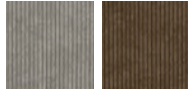

Colours:

Cream
Brown

Fabric covering

specifications:

Covering composition: 92% Polyester, 8% Nylon
Bonding: Polyester/Polyamide
Material weight: 300 g/lm
Tariff No.: 8501320000
Abrasion resistance
(EN ISO 12947 1 & 2): 40.000 cycles, Martindale
Pilling resistance
(EN ISO 12945-2): Class 4, 2.000 Rubs
Lightfastness
(EN ISO B02): Class 4

Filling and body:

Body: Wood fiber board, pinewood, hardwood,
hardboard
Seat suspension: Nosag springs
Seat filling: HR 3032 foam + SG25 foam covered
with dacron cotton wool 150 g/m2
Back filling: SG1818 foam
Legs: Black plastic

Vint couch

Corduroy velvet

Fabric group:

B (Corduroy rib velvet)



Colours:

Aged gold

Fabric covering

specifications:

Covering composition: 100% Polyester
Bonding: T/C
Material weight: 580 g/lm
Tariff No.: 60053700
Abrasion resistance
(EN ISO 12947 1 & 2): 55.000 cycles, Martindale
Pilling resistance
(EN ISO 12945-2): Class 5, 2.000 Rubs
Lightfastness
(EN ISO B02): Class 4-5

Filling and body:

Body: Wood fiber board, pinewood, hardwood,
hardboard
Seat suspension: Nosag springs
Seat filling: HR 3032 foam + SG25 foam covered
with dacron cotton wool 150 g/m2
Back filling: SG1818 foam
Legs: Black plastic

Care instructions:

Remove non-greasy stains by carefully dabbing with a lint-free cloth or sponge wrung out in clean warm water. If necessary, clean by dabbing with soapy water with a little dish soap. Finally, dab the surface with clean water. Avoid contact with sharp objects.



RETRO LOUNGE FAUTEUIL/OTTOMAN

Product fact sheet (MZM4898, MZM4942)

General specifications

Dimensions:

Fauteuil: 82x84x76 cm

Ottoman: 82x51x45 cm

Fabric specifications

Colour:

Cream

Fabric covering specifications:

- Composition front: 46% Acrylic, 54% Polyester
- Composition backing: 100% Polyester
- Coating: Y (white backing)
- Material weight: 630 g/m²
- Tariff No.: 5169200
- Abrasion Resistance
(ISO 12947-2:2016, Martindale Method, Force applied: 12kPa): > 40.000
(ASTM D3885-07a (2015): Commercially Acceptable
(ASTM D3884-09 (R2017): Commercially Acceptable
- Color Fastness To Light
(ISO 105-D01:2010): Class 4-5
(AATCC 16.3-2014, Option 3, Xenon-Arc Lamp): Commercially Acceptable

Filling and body:

- Body: Pine, plywood, D30+S30 foam, Nylon webbing
- Seat suspension: D30+S30 foam, Dacron, Nylon webbing
- Seat filling: D30+S30 foam, Dacron
- Back filling: D30+S30 foam, Dacron
- Legs: Rubber wood



Care instructions:

Remove non-greasy stains by carefully dabbing with a lint-free cloth or sponge wrung out in clean warm water. If necessary, clean by dabbing with soapy water with a little dish soap. Finally, dab the surface with clean water. Avoid contact with sharp objects.

DORIS FOR HK: LOBBY BENCH FLORAL PRINT

Product fact sheet (MZM4939)

General specifications

Dimensions:
140x40x45 cm

Fabric specifications

Colour:
Floral print

Fabric covering specifications:

- Covering composition: 100% Polyester
- Bonding: 1 side brush 100% Polyester
- Material Weight: 507 g/m²
- Tariff No.: 94018000
- Abrasion Resistance
(EN ISO 12947-2:2016; Martindale Wear & Abrasion Tester; 12kPa Pressure)
Exceeds 40.000 rubs
- Lightfastness: (EN ISO B02): Class 4

Filling and body:

- Body: Plywood, sponge, fabric, non-woven fabric, PVC
- Seat filling: Plywood, sponge, fabric
- Legs: Plywood, sponge, fabric, non-woven fabric, PVC foot pad

(Material composition: Plywood 89%, Fabric 7%, Sponge 4%)



Care instructions:

Remove non-greasy stains by carefully dabbing with a lint-free cloth or sponge wrung out in clean warm water. If necessary, clean by dabbing with soapy water with a little dish soap. Finally, dab the surface with clean water. Avoid contact with sharp objects.

LOBBY BENCH NATURAL (180 CM)

Product fact sheet (MZM4940)

General specifications

Dimensions:

180x40x45 cm

Fabric specifications

Colour:

Natural

Fabric covering specifications:

- Covering composition: 100% Polyester
- Bonding: 1 side brush 100% Polyester
- Material Weight: 420 g/m²
- Tariff No.: 94018000
- Abrasion Resistance
(EN ISO 12947-2:2016; Martindale Wear & Abrasion Tester; 12kPa Pressure.):
Exceeds 35.000 rubs
- Lightfastness: (EN ISO B02): Class 4

Filling and body:

- Body: Plywood, sponge, fabric, non-woven fabric, PVC
- Seat filling: Plywood, sponge, fabric
- Legs: Plywood, sponge, fabric, non-woven fabric, PVC foot pad

(Material composition: Plywood 90%, Fabric 6%, Sponge 4%)



Care instructions:

Remove non-greasy stains by carefully dabbing with a lint-free cloth or sponge wrung out in clean warm water. If necessary, clean by dabbing with soapy water with a little dish soap. Finally, dab the surface with clean water. Avoid contact with sharp objects.

Aluminium outdoor lounge sofa

Aluminium outdoor lounge sofa charcoal (MZM4987) - Aluminium outdoor lounge sofa olive (MZM4989) - Aluminium outdoor lounge sofa dusty orange (MZM5267)
Outdoor lounge sofa cushion set brown (MOU5007) - Outdoor lounge sofa cushion set black (MOU5008) - Outdoor lounge sofa cushion set brown/white XL (MOU5009)

General specifications

Dimensions lounge sofa:

220x84x63cm (seating height 25,5cm)

Material lounge sofa:

Aluminium

Colours lounge sofa:

Charcoal
Olive
Dusty Orange

Dimensions cushions:

Seat cushion 90x89x17cm / Back cushion 90x40x18cm

Dimensions XL cushions:

Seat cushion 108x89x17cm / Back cushion 108x40x18cm

Fabric specifications cushions

Colour cushions:

Black
Brown
Brown/white

Fabric covering specifications:

- Covering composition: 100% Olefin
- Fabric Weight: 357 gr/m2
- Tariff No.: 94018000
- Abstraction Resistance (rubs): BS EN 14465, 20000 rubs
- Colour fastness to Artificial Weathering: BS EN ISO 105:B04 - 7-8
- Colour fastness to Rubbing: EN ISO 105-X12
- Colour fastness to Chlorinated Pool Water: BS EN ISO 105-E03 - max 5
- Colour fastness to Sea Water: BS EN ISO 105-E02 - max 5
- Soil Release: AATCC 130
- Dimensional Stability to washing: EN ISO 6330, ASTM G53-96
- Weatherability: American Standard (hours), 1500
- Pilling Resistance: EN ISO - 12945 - 2, class 4-5, max 5 after 2000 rubs
- Seam Slippage: prEN ISO 13936 - 2, class 5
- Tear Strength: EN ISO 13937-3
- Tensile Strength: EN ISO 13934-1
- Water Repellency: AATCC Test Method 22 - 2005 - max 100
- Flammability: BS EN 1021-1, 2006 - Cigarette
- Anti Mildew: AATC 147 : 2011 & 30 : 2004

Filling:

- The cushions are filled with foam in combination with a layer of Hollow fiber/Dacron.



Wash instructions cushion:

Cushion covers can be washed by hand only with a soft detergent and warm water. Do not tumble dry. Do not iron.

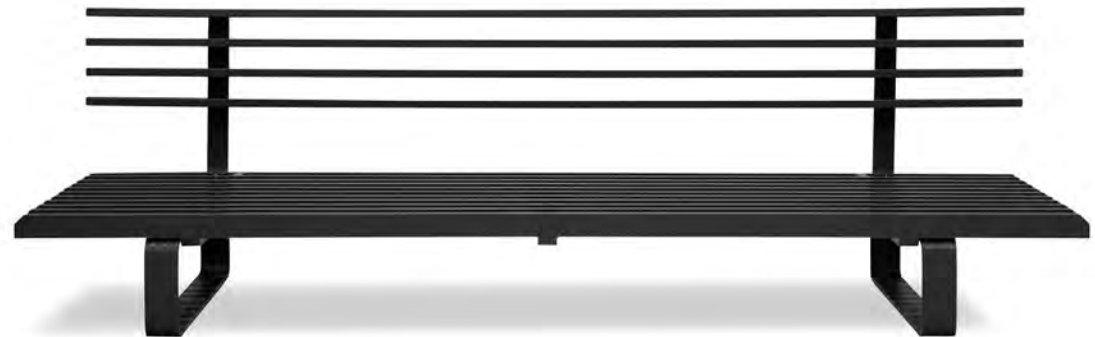
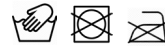

Care instructions lounge sofa:

Wash with a soft cloth and a mixture of a mild detergent and warm water. Rinse with warm water, and wipe dry with a clean, soft cloth. Do not use abrasive, acid, alcohol-based, or solvent-based cleaners; they will damage the surface and cause the metal to erode. Wipe up immediately using a clean, soft cloth. Store furniture indoors during winter.